

Three-Dimensional Fuzzy Logic Applied to DC Voltage Regulation in Active Power Filter of PV System

Fares Bourourou*[‡], Sis Ahmed Tadjer*[‡], Idir Habi*[‡]

* Department automatisaton et electrification des procedes, Faculty of hydrocarbons and chemistry, LREEL,

(f.bourourou@univ-boumerdes.dz, s.tadjer@univ-boumerdes.dz, i.habi@univ-boumerdes.dz)

[‡]Fares Bourourou, 35000 Boumerdes, Algeria, Tel: +213 551305610,

Fax: +213551305610, f.bourourou@univ-boumerdes.dz

Received:02.06.2023 Accepted:30.06.2023

Abstract- This paper deals with the application of three-dimensional fuzzy logic to DC voltage regulation in active power filters exploration, the benefits of this approach, and examples of its application on power quality improvement of PV smart grid system installation. APF are important components of power systems that are used to minimize harmonic distortion and improve power quality. DC voltage regulation is a critical component of active power filters, and traditional control systems have limitations in their ability to account for complex and nuanced conditions, leading to less accurate control and less efficient use of resources. Three-dimensional fuzzy logic is an advanced approach to control systems that allows for more precise and nuanced evaluations of conditions, compering to classical fuzzy logic or the type 2, leading to more accurate control and more efficient use of resources, Three-dimensional fuzzy logic algorithm will be proposed and programed under MATLAB Simulink to control the APF and simulation results are represented and analysed.

Keywords: Three-dimensional fuzzy logic; APF; Regulation; 3D membership function; power quality; PV.

1. Introduction

The purpose of this work is to integrate a smart PV system into the power supply system of an industrial company use power of 200 kw by exploiting the company recorded data, with these utilization factors daily, based on the detailed operating principle. Also in order to ensure the quality of the energy produced by the PV system [1] [2-4] dedicated to supplying the company's equipment, an APF will be installed after its sizing with these different control parts and data acquisitions as shown in "Figure 1" below: [3-7]

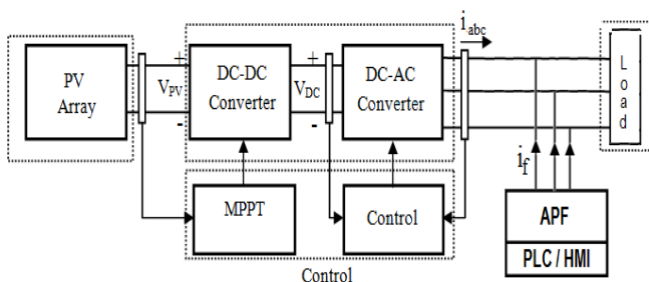

Fig.1 PV system diagrams with APF supplies 200 kw industrial manifactory

The study of each part of the installation leads us to determine the operating system at each hour of the day and the year; the power output in use is a function of the system elements characteristics, data of solar irradiance and temperature.

Modeling of PV system and mainly the solar panels in ideal conditions and simplified after sizing and the deduction of its characteristics make the study of MPPT commands influence on energy quality possible (the output voltage delivered by the proposed PV structure).[6][2]

The control of the proposed system is based on the new control technique Fuzzy three-dimensional logic theory presented on the next part of this work

2. Tree-Dimensional Fuzzy Logic

Fuzzy three-dimensional logic, also known as 3D fuzzy logic [8-16], is an extension of traditional fuzzy logic that

allows for modelling three-dimensional systems using three-dimensional fuzzy sets.

Where Fuzzy logic was first introduced in the 1960 as a mathematical framework for dealing with uncertainty and imprecision in data. It was originally developed for use in control systems, where precise, binary decisions were impractical. Fuzzy logic allowed for the creation of control systems that could make more flexible, nuanced decisions based on a range of input data.

In the early 1990s, researchers began to explore the use of fuzzy logic for modelling three-dimensional systems. One of the key challenges in this area was how to represent three-dimensional fuzzy sets mathematically. In 1992, Kaoru Hirota proposed a solution to this problem in a paper titled "Three-Dimensional Fuzzy Control." [12-15]

Hirota's approach involved dividing a three-dimensional fuzzy set into a series of two-dimensional slices, each of which represented a different level of membership in the set. By representing the fuzzy set in this way, it was possible to perform calculations more efficiently and accurately. [16]

3. Description of The Three-dimensional Fuzzy Logic

Three-dimensional fuzzy logic is an extension of traditional fuzzy logic that allows for the representation of fuzzy sets and membership functions in a three-dimensional space. This approach allows for more complex and nuanced evaluations of degrees of membership. Fuzzy logic is a mathematical approach that deals with uncertainty and imprecision by assigning degrees of truth rather than simply true or false. Traditional fuzzy logic represents fuzzy sets and membership functions in a two-dimensional space. In contrast, three-dimensional fuzzy logic represents fuzzy sets as volumes, called "3D membership functions." 3D membership functions are defined by mathematical equations that describe their shape and position in space. The fuzzy set is then determined by the intersection of several volumes. The fuzzy set of FLC and Type 2 FLC are represented in "Figure 2" below

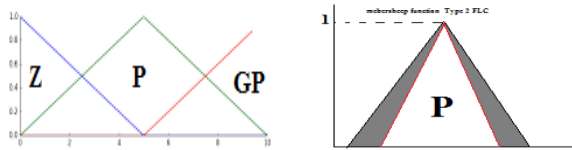

Fig.2 Classical fuzzy logic set

Where "fig.3" represents a tree dimensional fuzzy logic set

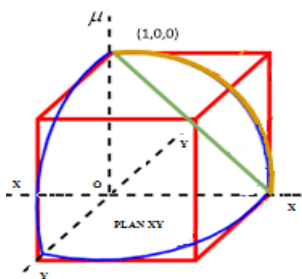

Fig.3 Tree dimensional fuzzy logic set

For the three dimensional axes X, Y, Z each axe has him three dimensional fuzzy set and the controller will use them all in the same time to estimate the values of either measurement and references and calculate the optimal estimated Control for the best regulation of APF DC Bus .

4. Three-Dimensional Fuzzy Logic Advantages

The benefits of three-dimensional fuzzy logic include more accurate control and more efficient use of resources. Traditional control systems have limitations in their ability to account for complex and nuanced conditions, leading to less accurate control and less efficient use of resources. Three-dimensional fuzzy logic allows for more precise and nuanced evaluations of conditions, leading to more accurate control and more efficient use of resources but this need more complex algorithms and calculator more powerful to analyse the big data include in lesser time possible.

5. Three-Dimensional Fuzzy Logic Control Principle

The most bases of the fuzzy logic controller are applied on three-dimensional fuzzy logic control but with three dimensional fuzzy set and the needed adaptation on fuzzification, inferences and defuzzification steps as shown on "fig.4" below proposed by Volodymyr MORIKUN and Olha KRAVCHENKO on 2021 in [1]

Fig.4 Three-dimensional fuzzy logic control principle

Three-dimensional fuzzy logic is based on mathematical principles, including set theory, fuzzy set theory, and fuzzy logic. Set theory is used to define the universe of discourse, or the set of all possible values of a variable. Fuzzy set theory is used to define fuzzy sets, which are sets that have degrees of membership. Fuzzy logic is used to determine the degree of membership of a value in a fuzzy set.

Where the general basic control structure is represented on "fig.5" describe the different parts of the fuzzy logic controller

Fig.5 Fuzzy logic controller structure

Also we can use the different bases rules of the traditional fuzzy logic with the three-dimensional fuzzy logic controller with the consideration of the three dimensional member sheep set function.

6. Three Dimensional Fuzzy Controller Algorithm

Three-dimensional fuzzy logic can be integrated into control systems using mathematical algorithms and programming languages. The algorithms are used to perform calculations and make decisions based on the input data and the fuzzy rule-based system. The programming languages are used to implement the algorithms and create the user interface for the control system[18][19].

The proposed controller algorithm steps are described on 7 points below:

- 1) Input and output variables definition
- 2) Member sheep function definition for each variable
- 3) Member sheep function plot
- 4) Control rules definition
- 5) Control rules aggregation
- 6) Global control rule plot
- 7) Command calculation

For the input variable we have taken error on position and the error variation with the integral of the error as third input variable

Obtained results are represented in “figure 6”, “figure 7” and “figure 8”

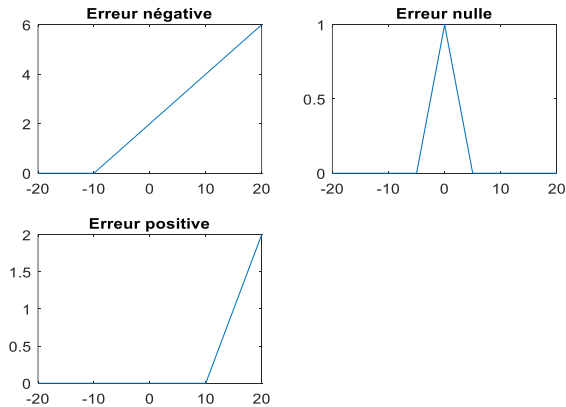

Fig.6 Three-dimensional fuzzy logic control input set “error”

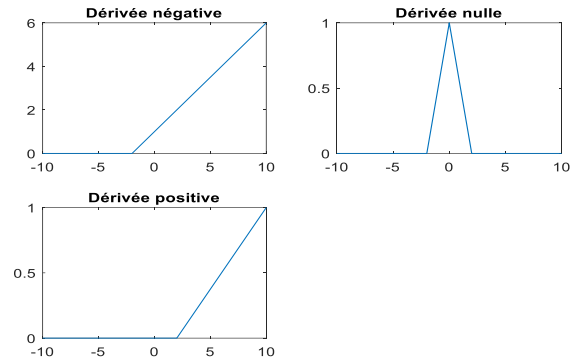

Fig.7 Three-dimensional fuzzy logic control input set “de”

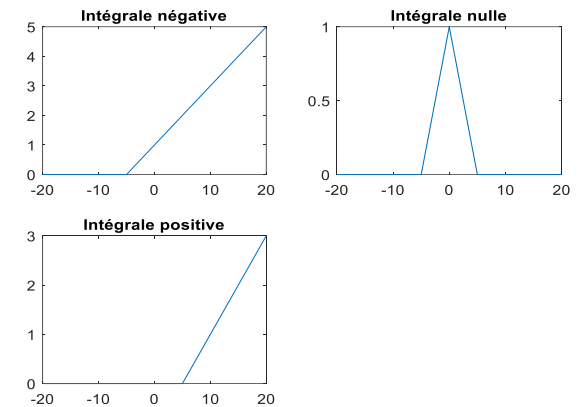

Fig.8 Three-dimensional fuzzy logic control input set “error integral”

Where the command output is represented by “fig.9”

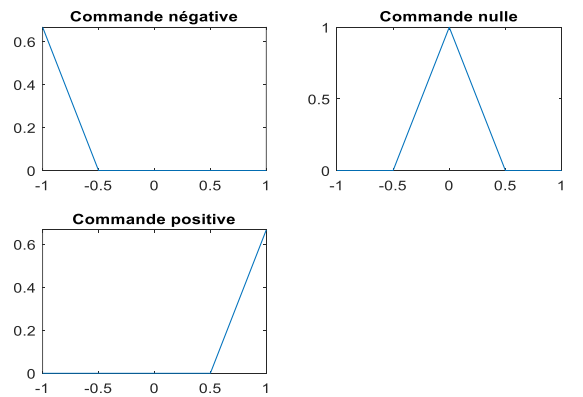

Fig.9 Three-dimensional fuzzy logic control output set “u”

And the control rules are represented on “fig.10”

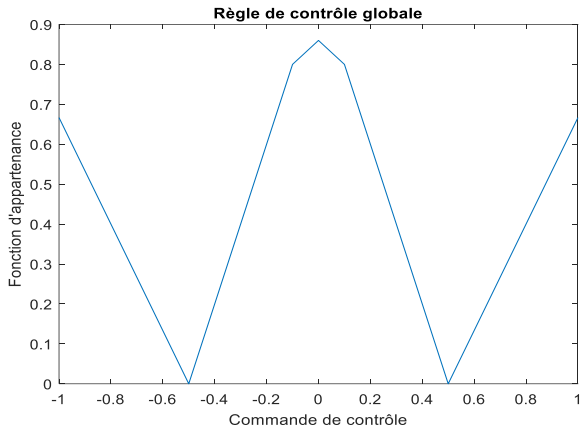

Fig.10 Three-dimensional fuzzy logic global control rules

7. Three-Dimensional Fuzzy Logic Applied To APF Dc Voltage Regulation

The efficiency of many commercial modules is not constant and depending on the illumination. This phenomenon is very often neglected by the manufacturers, who give no indication of the behavior of their module at low illumination; [12] [14] the following curves in “Figure 11” shows the variation in power values given by a 250 Wp PV panel under standard conditions at a fixed temperature T equal to 25°C variable during the variation in irradiation (a) then T variable with 1000w/m² (b).

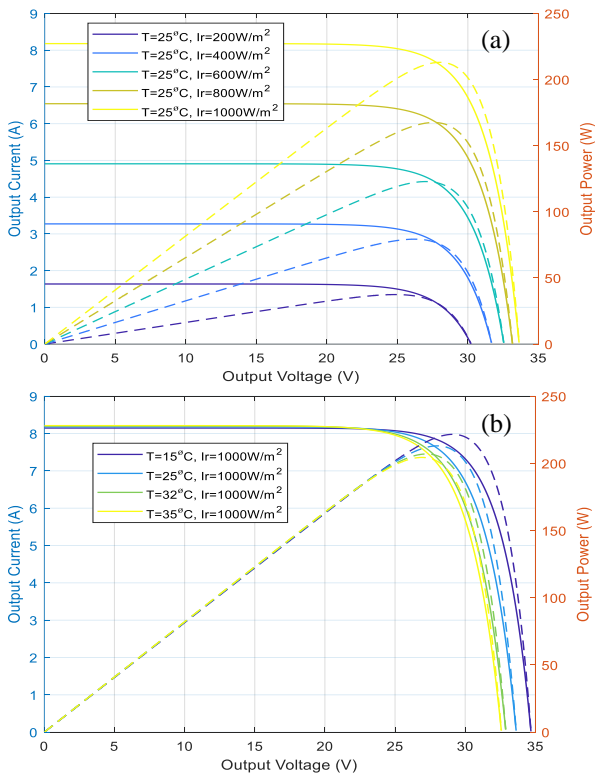

Fig.11 P(V) Characteristic for different values of irradiance/temperature.

The power delivered by a PV depends on the ambient temperature, the wind speed, the mounting of the module (integrated in the roof or ventilated) and all these parameters change according to the chosen site for modules installation. In addition, the coefficients linked to the temperature differ according to the materials used for the manufacture of the module. [12]

Temperature is a very important parameter in the behavior of PV cells [13]. “Figure 11” (b) Describes the behavior of the module under a fixed illumination of 1000W/m², and at temperatures between 15°C and 40°C. We notice that the current increases with the temperature; on the other hand, the open circuit voltage decreases. This leads to a decrease in the maximum power available.

The simulation bloc diagram represented in “figure 12”

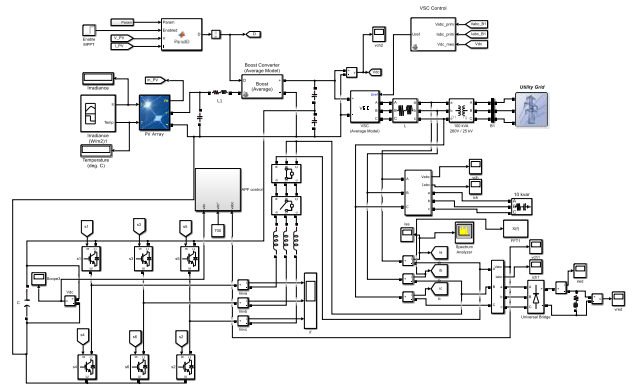

Fig.12 Simulation bloc of smart grid PV connected to network

Three-dimensional fuzzy logic can be applied in DC voltage regulation in active power filters. It has used to regulate the DC voltage of the active power filter based on observed measurements, such as the current and voltage of the filter. It was used to adjust the switching frequency of the filter in response to changing conditions, such as variations in the load and satisfy the coupling conditions between the PV system and the network of the smart grid.

Where the simulation results are shown on below “figure 13”, “figure 14” and “figure 15” representing the dc voltage of the APF and The harmonic specter of current before and after filter connection

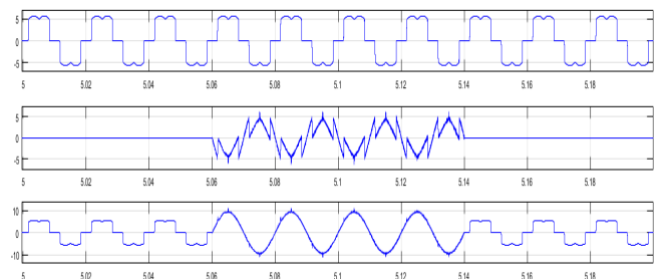

Fig.13 Simulation result of smart grid PV with APF

The harmonic specter of current before APF connection to the smart grid is represented on figure 14

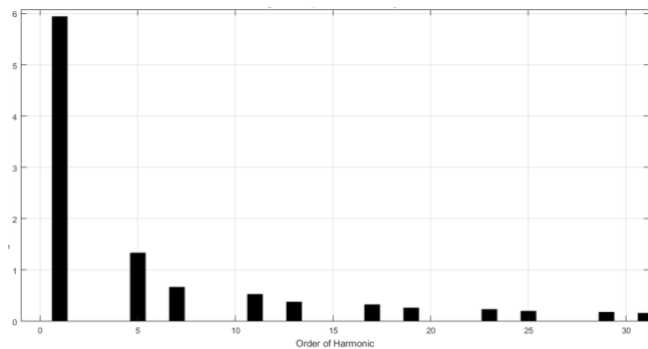

Fig.14 Current harmonic specter of smart grid-PV

Where the “figure 14” represent the specter harmonic after connection of APF to the smart grid

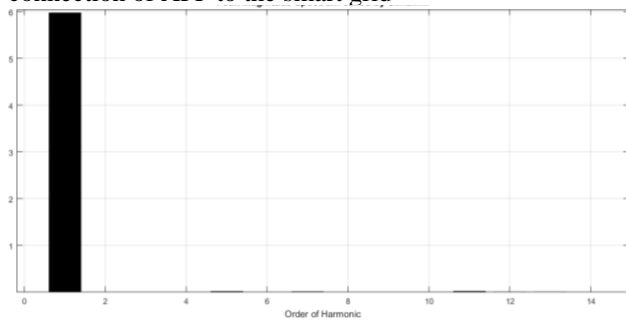

Fig.15 Current harmonic specter of smart grid-PV-APF

The simulation results present the role of the APF on power quality improvement according to the APF DC bus control by the fuzzy logic controller shown in “figure 16”

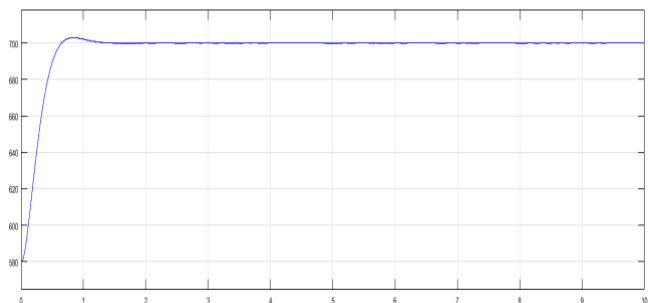

Fig.16 APF DC bus control of smart grid-PV

The response time is less than 0,7s and the dc voltage on permanent regime has a fix value equal to the needed reference.

Three-dimensional fuzzy logic has also been applied in process control as artificial intelligence technique.

8. CONCLUSIONS

Three-dimensional fuzzy logic is an advanced approach to control systems that allows for more precise and nuanced evaluations of conditions, leading to more accurate targeting and more efficient use of resources. It can be applied in many fields, including APF control, where it can be used to regulate the thrust, voltage, and harmonic order control of the smart PV system based on observed measurements. The mathematical integration of three-dimensional fuzzy logic in

control systems is based on set theory, fuzzy set theory, and fuzzy logic, and can be implemented using mathematical algorithms and programming languages. With its ability to handle complex and nuanced conditions, three-dimensional fuzzy logic has the potential to revolutionize the field of control systems and improve the accuracy and efficiency of many processes

ACKNOWLEDGMENT

My Acknowledgment are directed to the LREEI laboratory director, professor I.Habi and FHC on the university of M’Hamed Bougara of Bumerdes.

REFERENCES

- [1] V. Prakash, T. Rama SubbaReddy, S. TaraKalyani, P.B.Karandikar, “integration of photovoltaic energy for improving power quality of UPQC”, J. Electrical Systems 17-1, p 105-120, 2021.
- [2] S. A. Tadjer, I. Habi,, M. El Ganaoui, S. Angel, “Direct components extraction of voltage in photovoltaic active filter connected in a perturbed electrical network (based on robust PLL algorithm)”, International Conference on Technologies and Materials for Renewable Energy, Environment and Sustainability, TMREES15; science direct Energy Procedia74 (2015) 966 – 972, 2015.
- [3] M. Kh. AL-Nussairi; S.D.Al-Majidi; A. Raisan Hussein; R. Bayindir, "Design of a Load Frequency Control based on a Fuzzy logic for Single Area Networks", 10th International Conference on Renewable Energy Research and Application (ICRERA), 2021 IEEE
- [4] L. zellouma, B. rabhi, A. krama, A. benaissa, m. Benkhoris .,”simulation and real time implementation of three phase four wire shunt active power filter based on sliding mode controller”, Rev. Roum. Sci. Techn.–Électrotechn. et Énerg, Vol. 63, 1, pp. 77–82, Bucarest, 2018.
- [5] M. Kingsley-Amaehule, R. Uhumwangho, N. Nwazor, Okedu and K. E, "Smart Intelliegent Monitoring and Maintenance Management of Photo-Voltaic Systems," International Journal of Smart Grid, vol. 6, no. 4, pp. 110-122, 2022
- [6] A. Abdalrhman, A. Zekry, A. Alshazly. “Simulation and Implementation of Grid-connected Inverters”. International Journal of Computer Applications, VOL. 60,NO. 4, PP 41-49, December 2012.
- [7] K. Tsamaase; J. Sakala; E. Rakgati; I. Zibani; K. Motshidisi, "Solar PV Module Voltage Output and Maximum Power Yearly profile using Simulink-based Model", 10th International Conference on Renewable Energy Research and Application (ICRERA), 2021 IEEE
- [8] J. C. Bezdek, & Pal, S. K. “Fuzzy Models for Pattern Recognition”. IEEE Press, 1992.
- [9] Y. Shimizu; H. Kitano, "Exchangeable batteries for micro EVs and renewable energy Taichiro Sakagami",

- 6th International Conference on Renewable Energy Research and Applications (ICRERA), 2017 IEEE
- [10] Gu, Y., & Wang, L. X. *Fuzzy Control and Modeling: Analytical Foundations and Applications*. IEEE Press, 2002.
- [11] K. A.-G. Moafaq, R. T. ahmed and T. C. Miqdam, "The Influence of Temperature and Irradiance on Performance of the Photovoltaic Panel in the Middle Of Iraq," *International Journal of Renewable Energy Development (IJRED)*, vol. 11, no. 2, pp. 501-513, 2022.
- [12] H. Li., D. Wang, Y. Liang, "Three-dimensional fuzzy control method for voltage regulation in photovoltaic stations". *Journal of Renewable Energy*, 32(11), 1874-1884., 2007.
- [13] J. Liu, X. Huang, "Three-dimensional fuzzy control of voltage regulation in photovoltaic stations based on genetic algorithm", *International Journal of Control and Automation*, 11(1), 45-54, 2018.
- [14] Y. Yang, C. Liu, "Three-dimensional fuzzy control of voltage regulation in photovoltaic stations based on improved particle swarm optimization algorithm", *International Journal of Control and Automation*, 10(12), 95-104., 2017.
- [15] Y. Chen, Y.A. Li, *Three-Dimensional Fuzzy Control Strategy for Permanent Magnet Synchronous Generator Wind Turbine Systems*. *IEEE Transactions on Power Electronics*, 34(10), 10059-10072, 2019.
- [16] V. Morkun, O. Kravchenko, "Three-Dimensional Fuzzy Control Of Ultrasonic Cleaning", *Acta Mechanica Et Automatica*, Vol.15 No.3, 2021.
- [17] B. Boukezata, A. Chaoui, J.P. Gaubert, and M. Hachemi, *Photovoltaic solar system connected to the electrical network and associated with a parallel active filter*, *Electrical Engineering Symposium*, Cachan, 2014.
- [18] M. H. Díaz-Araujo, A. Medina-Rios, M. Madrigal-Martínez, L. A. Cleary-Balderas, "Analysis of Grid-Connected Photovoltaic Generation Systems in the Harmonic Domain", *Energies* 12. 2019.
- [19] A. Bouhouta; S. Moulahoum; N.Kabache; I.Colak, "Simplicity and Performance of Direct Current Control DCC Compared with other Identification Algorithms for Shunt Active Power Filter", *7th International Conference on Renewable Energy Research and Applications (ICRERA)*, 2018